

GOLDBERG BROTHERS BARN DOOR HARDWARE

MP Series Bypass - Installation Instructions

6008BP3-*, 6008BP4-*

Included Hardware

Bypass wall bracket (6)
3/4" Carriage bolt (12)

Bracket extender (6)
Keps nuts (12)

Hex head bolt 1 3/4" (2)
Hex lag bolts (12)

Hex head bolt 1 1/2" (4)

The following instructions detail the installation steps specifically for the MP Series bypass system. The MP Series straight strap or J-strap hardware set and track installation should be completed first.

IMPORTANT

Before beginning the installation of your bypass system, please determine whether you will have a **CLEAR OPENING** or **PASS THROUGH** system and follow the instructions below accordingly.

CLEAR OPENING

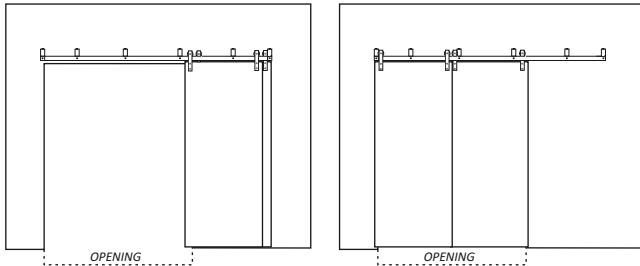

Where doors stack collectively on either or both sides of the opening to leave the opening clear and free from obstruction.

PASS THROUGH

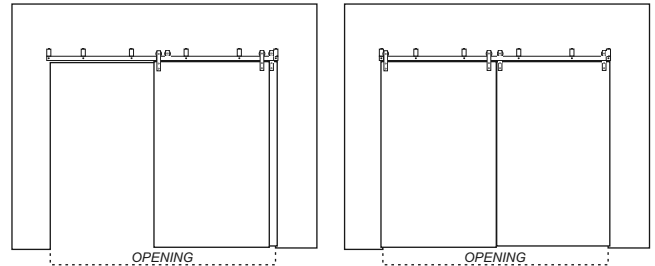

Where doors slide freely, in either direction and stack within the opening to leave only one side of the opening clear.

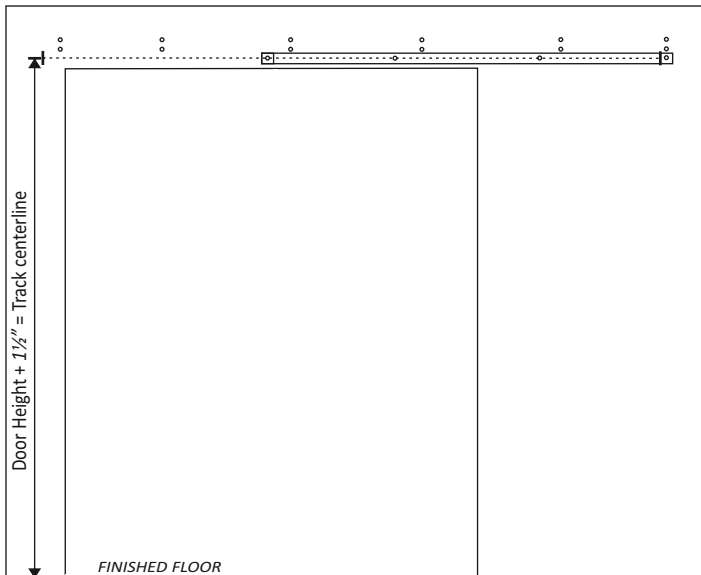

Use the front track to determine the spacing for the bypass bracket pilot holes.

Note: The first bracket holes will align with the end hole on the existing wall-mounted track as shown.

The track connecting points on the front track will not always align with the track connecting points on the existing wall-mounted track.

Drill 1/8" pilot holes 1 1/4" and 2 3/4" above the centerline of the existing wall-mounted track.

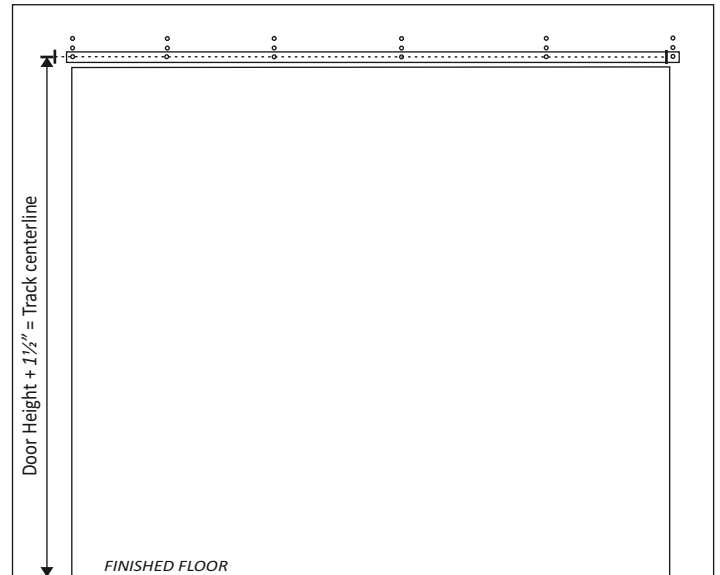

Use the front track to determine the spacing for the bypass bracket pilot holes.

Note: The bracket holes will align with the track connecting points on the existing wall-mounted track as shown.

Drill 1/8" pilot holes 1 1/4" and 2 3/4" above the centerline of the existing wall-mounted track.

Using the provided hex lag bolts, attach the bypass wall brackets to the wall as shown.

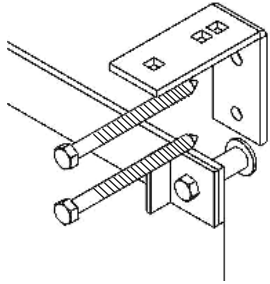

Using the provided 3/4" carriage bolts and keps nuts, attach the bypass extender brackets to the wall brackets as shown.

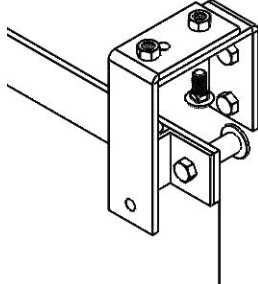

Using the provided hex head bolt attach the second track to the extender bracket as shown.

Notes: The spacers and washers were provided with the MP J-strap or MP straight strap hardware sets.

The 1 3/4" hex head bolts are for the stops at each end. The 1 1/2" hex head bolts are for the remaining connecting points.

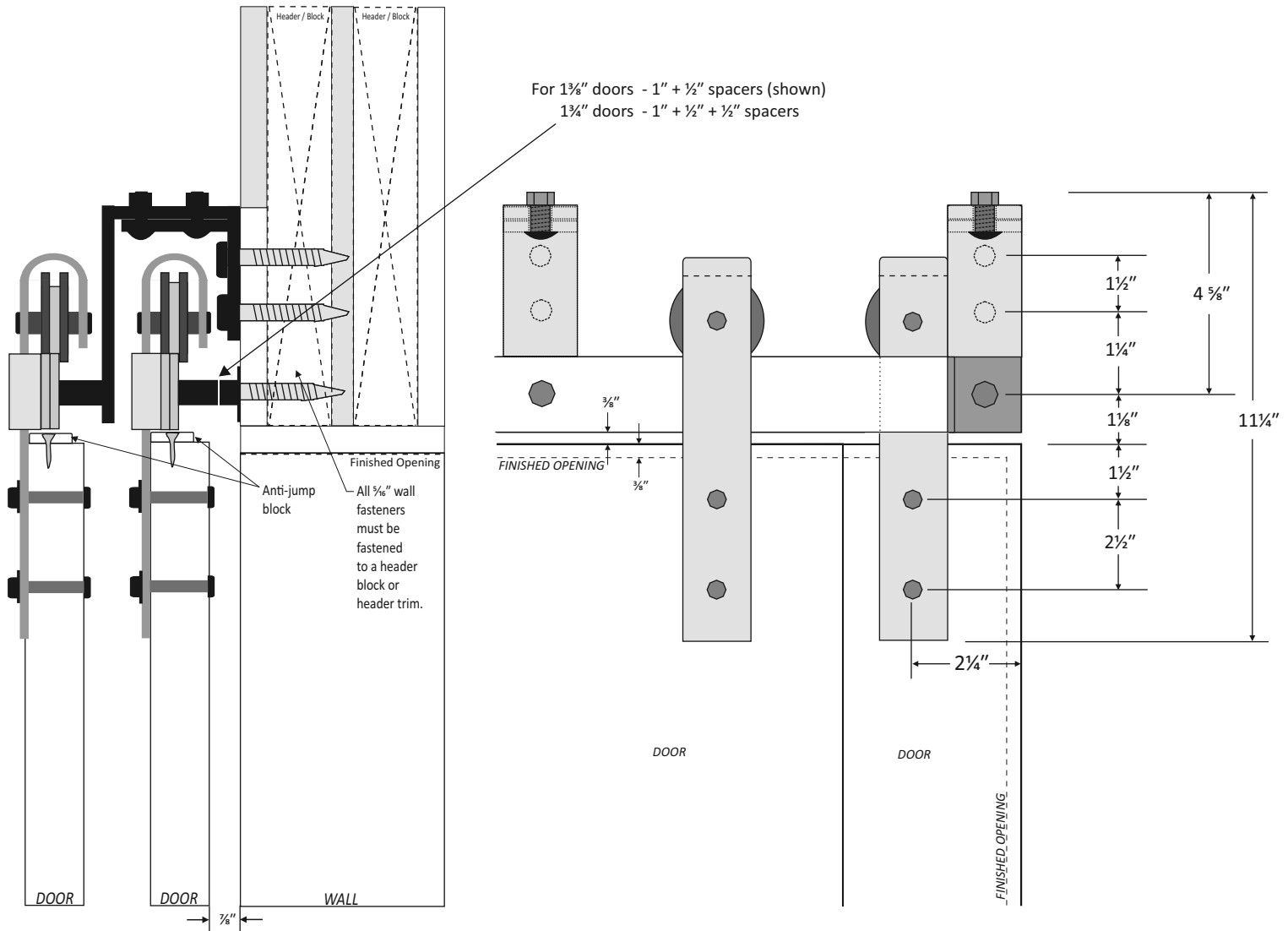
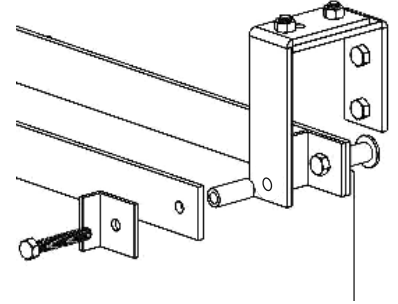

Limited Lifetime Warranty

Goldberg Brothers warrants the functionality of its barn door hardware sets and tracks with a limited lifetime manufacturer's warranty for defective parts under normal installation and use. Warranty is subject to repair or replacement of defective components at manufacturer's discretion and does not include installation costs.

This warranty does not apply to the cosmetic condition of any products or components. Goldberg Brothers barn track is sold as a rustic finished hardware and may develop scratches or other signs of wear during manufacturing or normal installation and use. Further, Goldberg Brothers does not warrant against any cosmetic imperfections in the steel parts that may be seen through the finish.

Certain accessories included but not limited to felt strips, rubber bumper bands, and Soft Stop motion buffer mechanisms have finite expected lifetimes due to wear and loss of tension or resilience during normal use over an extended period. Except for manufacturing defects that become apparent within 1 year of purchase, these accessories are not covered under this limited lifetime warranty. Replacement accessories may be purchased as needed from Goldberg Brothers retailers. Except for stainless steel components, Goldberg Brothers barn door hardware products are not warranted against rust. Some rusting is possible on any raw steel or powder coated steel hardware installed outdoors or anywhere else that it may be exposed to high humidity, rain, snow, or running water.

This warranty does not include loss or defects caused by elements outside the control of Goldberg Brothers, Inc., such as natural disasters, weather, fire, water leakage, abuse, improper installation, or anything else deemed out of the control of Goldberg Brothers, Inc.



Goldberg Brothers, Inc.
 10488 W Centennial Rd, Suite 100
 Littleton, CO 80127
 (303) 321-1099